



Wózek narzędziowy z wyposażeniem

Model: 7 szuflad – 261 sztuk narzędzi

W/7-Drawer Tool Trolley - 261PCS Contents

1ST DRAWER

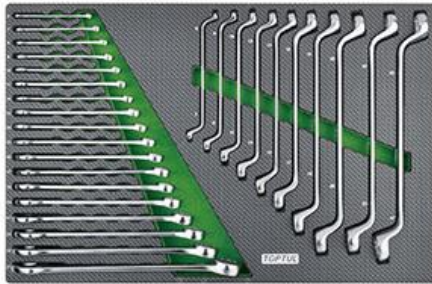

GVD2803

2ND DRAWER



GVA5004

GVC3903

3RD DRAWER



GVC6101

GVA3002

4TH DRAWER



GVB2503

GVB1202

5TH DRAWER



GVA0807

GVA0405

GVA0406

Kliknij na wybraną wkładkę i wybierz indywidualne narzędzie.

Indeks: GE-26105

Indeks: GE-26106

Indeks: GE-26109

Kolor i faktura wytłoczek w prezentowanych modelach wózku są takie jak na zdjęciach zamieszczonych przy specyfikacjach poszczególnych wytłoczek.







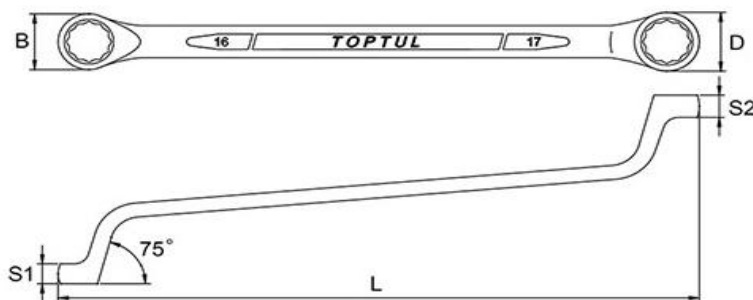
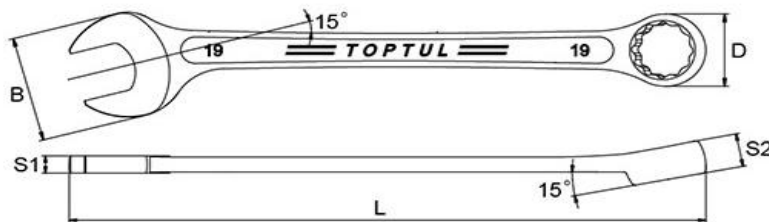
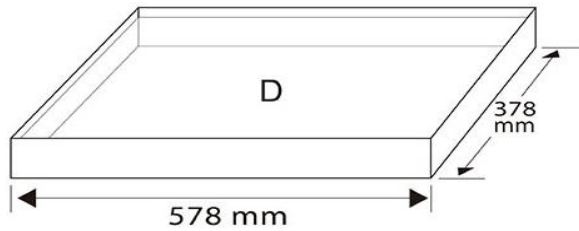

Item no.	Content / Zawartość	Size [mm]	L [mm]	Zam./Order	
GVD2803	18	AAEX0606	6	104	
		AAEX0707	7	114	
		AAEX0808	8	124	
		AAEX0909	9	131	
		AAEX1010	10	143	
		AAEX1111	11	151	
		AAEX1212	12	160	
		AAEX1313	13	169	
		AAEX1414	14	180	
		AAEX1515	15	192	
		AAEX1616	16	198	
		AAEX1717	17	206	
		AAEX1818	18	214	
		AAEX1919	19	223	
		AAEX2121	21	243	
		AAEX2222	22	255	
		AAEX2424	24	274	
		AAEX2727	27	304	
	10	AAEI0607	6x7	167	
		AAEI0809	8x9	182	
		AAEI1011	10x11	197	
		AAEI1213	12x13	218	
		AAEI1415	14x15	238	
		AAEI1617	16x17	258	
		AAEI1819	18x19	290	
		AAIE2022	20x22	316	
		AAEI2123	21x23	316	
		AAEI2427	24x27	328	



D



Item no.	Content / Zawartość	Size [mm]	L [mm]		Zam./Order
GVA5004	13	BAEA0804	4	-	1/4"
		BAEA084E	4,5	-	1/4"
		BAEA0805	5	-	1/4"
		BAEA085E	5,5	-	1/4"
		BAEA0806	6	-	1/4"
		BAEA0807	7	-	1/4"
		BAEA0808	8	-	1/4"
		BAEA0809	9	-	1/4"
		BAEA0810	10	-	1/4"
		BAEA0811	11	-	1/4"
		BAEA0812	12	-	1/4"
		BAEA0813	13	-	1/4"
		BAEA0814	14	-	1/4"
		8	BAEE0806	6	-
	BAEE0807		7	-	1/4"
	BAEE0808		8	-	1/4"
	BAEE0809		9	-	1/4"
	BAEE0810		10	-	1/4"
	BAEE0811		11	-	1/4"
	BAEE0812		12	-	1/4"
	BAEE0813	13	-	1/4"	
	5 	BCDA0803	3	-	1/4"
		BCDA0804	4	-	1/4"
		BCDA0805	5	-	1/4"
		BCDA0806	6	-	1/4"
		BCDA0808	8	-	1/4"
	3 	BCCA0803	3	-	1/4"
		BCCA085E	5,5	-	1/4"
		BCCA0808	8	-	1/4"
	3 	BCAA08P0	PH0	-	1/4"
		BCAA08P1	PH1	-	1/4"
		BCAA08P2	PH2	-	1/4"
	3 	BCBA08P0	PZ0	-	1/4"
		BCBA08P1	PZ1	-	1/4"
		BCBA08P2	PZ2	-	1/4"
	1	CAIP0816	-	165	1/4"
	1	CTCK0811	-	115	1/4"
	1	CAHA0840	-	-	1/4"
	2	CAAA0802	-	50	1/4"
		CAAA0806	-	150	1/4"
	1	CJBM0815	-	145	1/4"
	9  	GAAL0917	1,5; 2; 2,5; 3; 4; 5; 6; 8; 10		

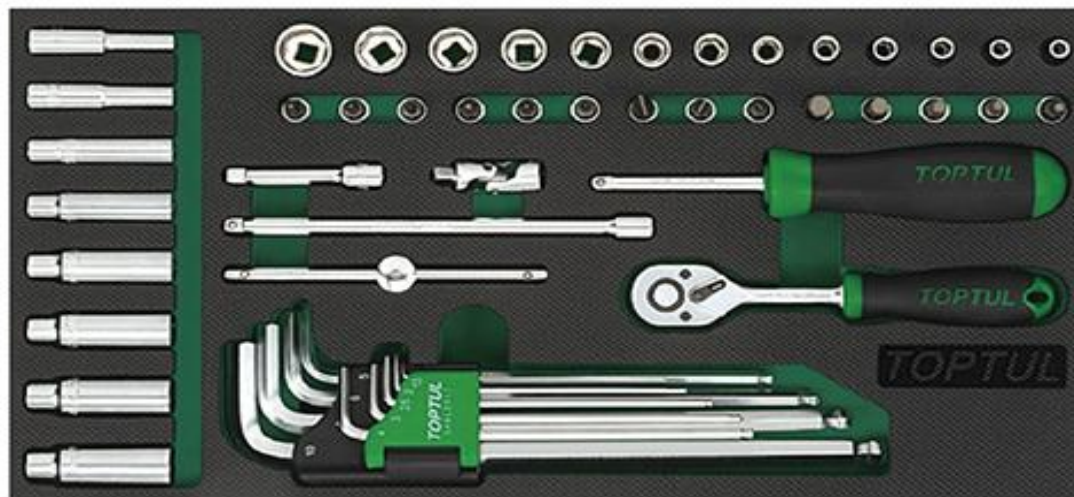

A



W192 x D375 x H32 (mm)

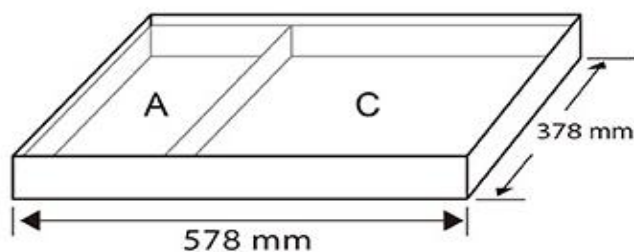
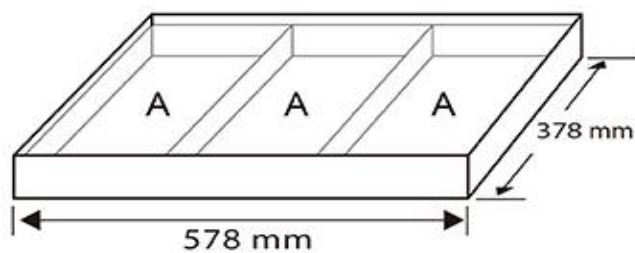

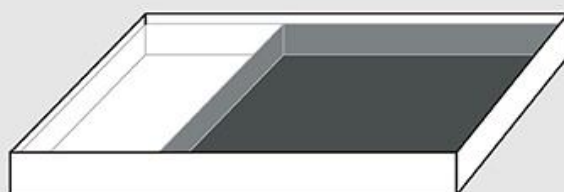



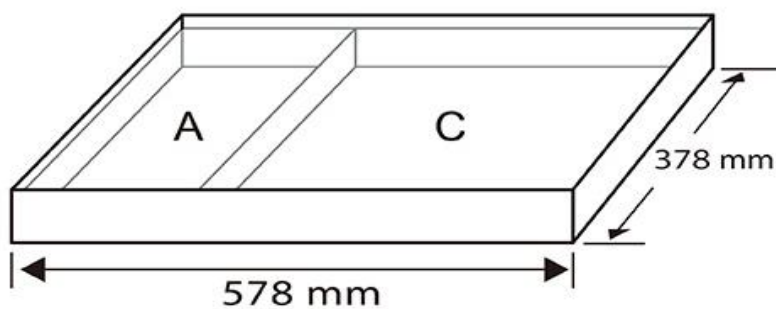



W383 x D375 x H32 (mm)









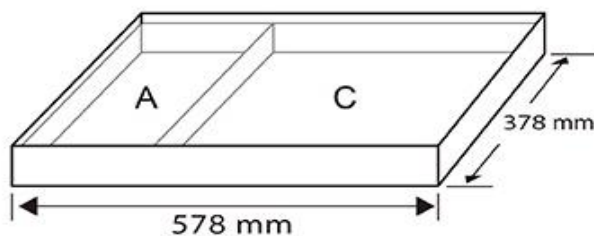
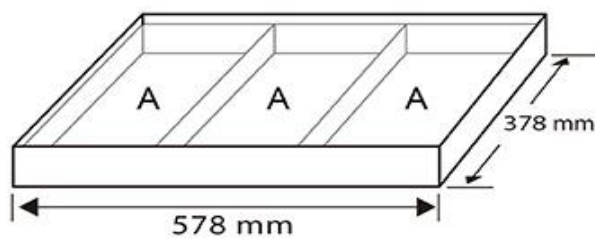
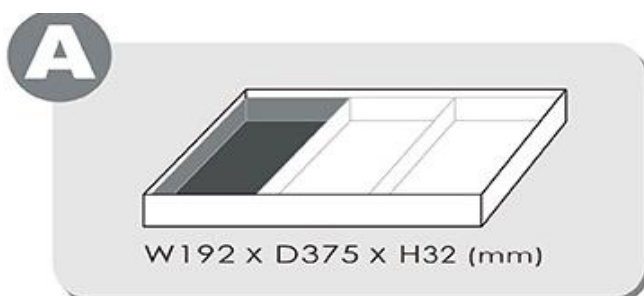

Item no.	Content / Zawartość	Size [mm]	L [mm]		Zam./Order	
GVC6101	4	AAEE0608	E6xE8	113	-	
		AAEE1012	E10xE12	142	-	
		AAEE1418	E14xE18	181	-	
		AAEE2024	E20xE24	224	-	
	2 	FFIB0605	T6	140	-	
		FFIB0705	T7	140	-	
	9 	FFAB0808	T8	162	-	
		FFAB0908	T9	162	-	
		FFAB1008	T10	162	-	
		FFAB1508	T15	180	-	
		FFAB2010	T20	205	-	
		FFAB2510	T25	215	-	
		FFAB2710	T27	215	-	
		FFAB3013	T30	240	-	
		FFAB4015	T40	275	-	
	5	BAED0804	E4	-	1/4"	
		BAED0805	E5	-	1/4"	
		BAED0806	E6	-	1/4"	
		BAED0807	E7	-	1/4"	
		BAED0808	E8	-	1/4"	
	4	BAED1210	E10	-	3/8"	
		BAED1211	E11	-	3/8"	
		BAED1212	E12	-	3/8"	
		BAED1214	E14	-	3/8"	
	4	BAED1616	E16	-	1/2"	
		BAED1618	E18	-	1/2"	
		BAED1620	E20	-	1/2"	
		BAED1624	E24	-	1/2"	
	6 	BCFA0810	T10	-	1/4"	
		BCFA0815	T15	-	1/4"	
		BCFA0820	T20	-	1/4"	
		BCFA0825	T25	-	1/4"	
		BCFA0827	T27	-	1/4"	
		BCFA0830	T30	-	1/4"	
2 	BCFA1240	T40	-	3/8"		
	BCFA1245	T45	-	3/8"		
3 	BCFA1650	T50	-	1/2"		
	BCFA1655	T55	-	1/2"		
	BCFA1660	T60	-	1/2"		
9 	GAAL0913	T10, T15, T20, T25, T27, T30, T40, T45, T50				



Item no.	Content / Zawartość	Size [mm]	L [mm]		Zam./Order	
GVA3002	16	BAEA1208	8	-	3/8"	
		BAEA1209	9	-	3/8"	
		BAEA1210	10	-	3/8"	
		BAEA1211	11	-	3/8"	
		BAEA1212	12	-	3/8"	
		BAEA1213	13	-	3/8"	
		BAEA1214	14	-	3/8"	
		BAEA1215	15	-	3/8"	
		BAEA1216	16	-	3/8"	
		BAEA1217	17	-	3/8"	
		BAEA1218	18	-	3/8"	
		BAEA1219	19	-	3/8"	
		BAEA1220	20	-	3/8"	
		BAEA1221	21	-	3/8"	
		BAEA1222	22	-	3/8"	
		BAEA1224	24	-	3/8"	
	7	BEAA1208	8	-	3/8"	
		BEAA1210	10	-	3/8"	
		BEAA1212	12	-	3/8"	
		BEAA1213	13	-	3/8"	
		BEAA1214	14	-	3/8"	
		BEAA1217	17	-	3/8"	
		BEAA1219	19	-	3/8"	
	3	CAAA1203	-	75	3/8"	
		CAAA1206	-	150	3/8"	
		CAAA1210	-	250	3/8"	
	1	CTCK1220	-	200	3/8"	
	1	CAHA1254	-	-	3/8"	
	1	CJBG1220	-	200	3/8"	
	1	CJHM1228	-	280	3/8"	





Item no.	Content / Zawiera	Size	L [mm]		Zam./Order	
GVB2503	10 	BCDA1604	4 mm	55	1/2"	
		BCDA1605	5 mm	55	1/2"	
		BCDA1606	6 mm	55	1/2"	
		BCDA1607	7 mm	55	1/2"	
		BCDA1608	8 mm	55	1/2"	
		BCDA1610	10 mm	55	1/2"	
		BCDA1612	12 mm	55	1/2"	
		BCDA1614	14 mm	55	1/2"	
		BCDA1617	17 mm	55	1/2"	
		BCDA1619	19 mm	55	1/2"	
	6 	BCFA1620	T20	55	1/2"	
		BCFA1625	T25	55	1/2"	
		BCFA1627	T27	55	1/2"	
		BCFA1630	T30	55	1/2"	
		BCFA1640	T40	55	1/2"	
		BCFA1645	T45	55	1/2"	
	3 	BCXA1650	T50	80	1/2"	
		BCXA1655	T55	80	1/2"	
		BCXA1660	T60	80	1/2"	
	1 	BCUA1670	T70	140	1/2"	
4 	BCJA1606	M6	100	1/2"		
	BCJA1608	M8	100	1/2"		
	BCJA1610	M10	100	1/2"		
	BCJA1612	M12	100	1/2"		
1 	BCJD1614	M14	100	1/2"		

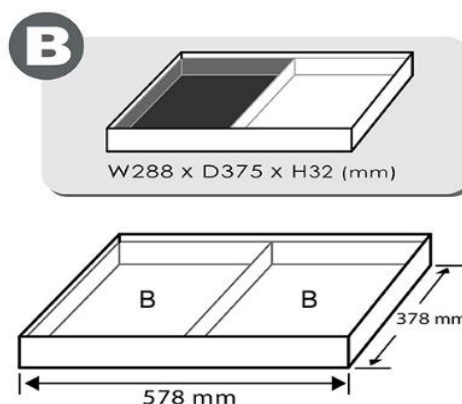
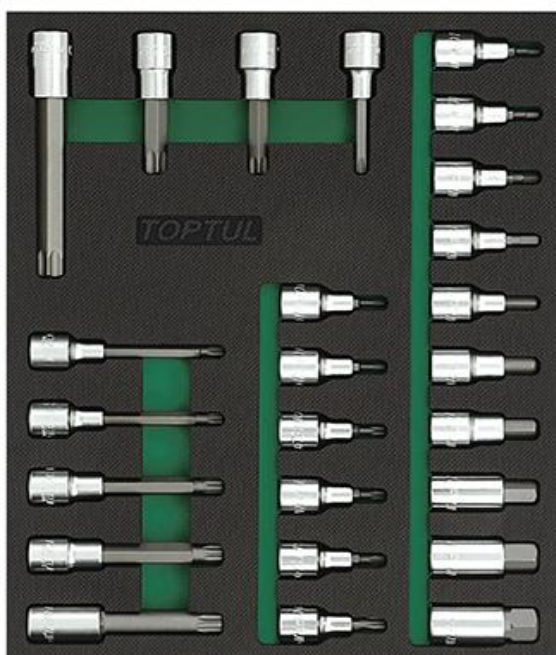



Item no.	Content / Zawiera	Size		Zam./Order	
GVA0807	1	HAAA0532	Engineers Hammer (500g)		
	4	HBAA0313	3x130	mm	
		HBAA0415	4x150	mm	
		HBAA0516	5x160	mm	
		HBAA618	6x180	mm	
	2	HCAB1918	19x180	mm	
		HCAB2522	25x220	mm	
	1	HBAB0414	4x140	mm	

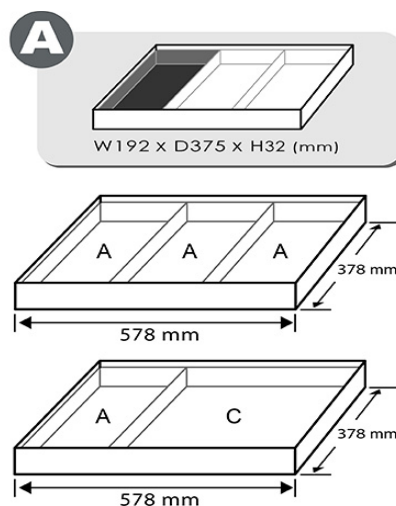



Item no.	Content / Zawiera		Size	Zam./Order
GVA0405	1	DEBC2207	Heavy Duty Diagonal Cutting Pliers - 7" (L)	
	1	DBBB2207	Combination Pliers - 7" (L)	
	1	DFBB2208	Long Nose Pliers - 8" (L)	
	1	DFBA2208	Bent Nose Pliers - 8" (L)	

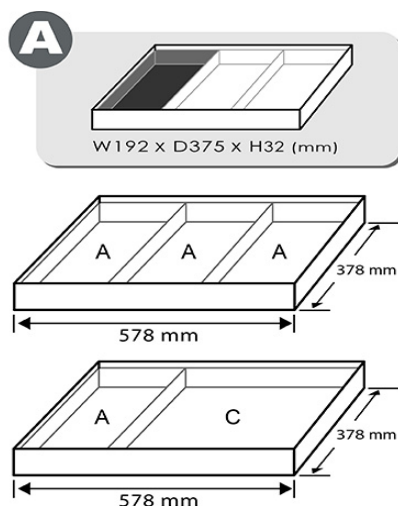
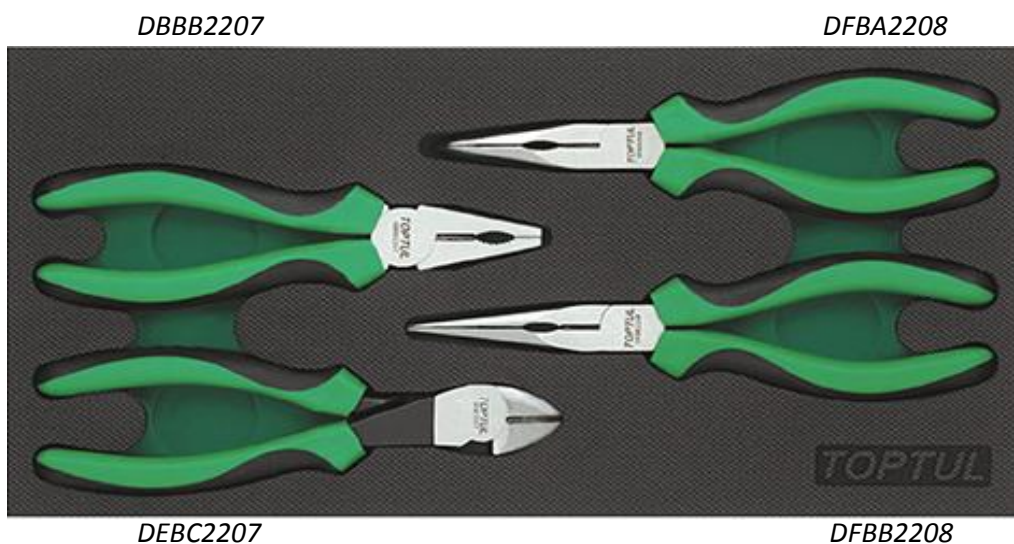

Item no.	Content / Zawiera		Size	Zam./Order
GVA0406	1	DCAA1207	90° Retaining Ring Pliers (External Ring) - 7" (L)	
	1	DCAB1207	Straight Retaining Ring Pliers (External Ring) - 7" (L)	
	1	DCAC1207	90° Retaining Ring Pliers (Internal Ring) - 7" (L)	
	1	DCAD1207	Straight Retaining Ring Pliers (Internal Ring) - 7" (L)	

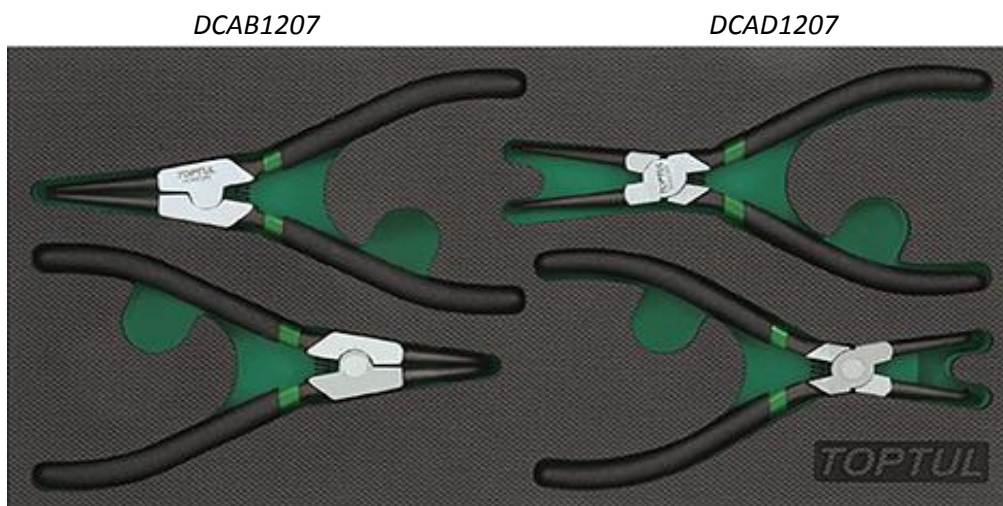

DCAA1207

DCAC1207

